

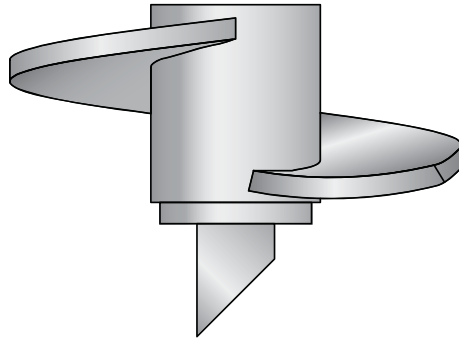

## TAX-250-625 (8) -- Torque Anchor Extreme Helix



### Product Specifications

Anchor Style	Power Installed Torque Anchor
Number of Helices	1
Single Helix	8" (203 mm) x 3/8" (9.52mm)
Rod Diameter	5/8" (15.9 mm)
Torque Rating	10,000 ft lbs (13,558 N-M)
Square Hub	2.5" (63.5 mm)
Coating	Painted (optional Hot-Dip Galvanized)
Standard Package	25
Standard Package Unit	Each
Min Order Qty	1
Weight/Ea	22 lbs

### Notes

Torque Anchor Extreme Helix; 10,000 ft lbs (13,558 N-M), 8" (203 mm) x 3/8" (9.52mm) Helix for use with 5/8" (15.9 mm) rod