

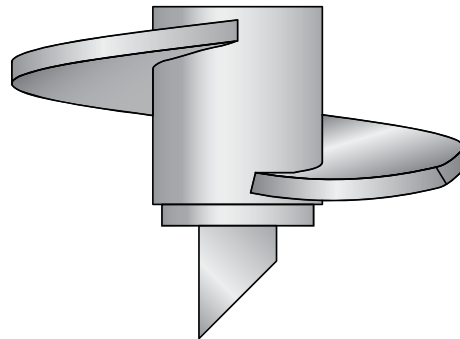

TAX-250-100 (8) -- Torque Anchor Extreme Helix



Product Specifications

Anchor Style	Power Installed Torque Anchor
Number of Helices	1
Single Helix	8" (203 mm) x 3/8" (9.52mm)
Rod Diameter	3/4" (19.1 mm) or 1" (25.4 mm)
Torque Rating	10,000 ft lbs (13,558 N-M)
Square Hub	2.5" (63.5 mm)
Coating	Painted (optional Hot-Dip Galvanized)
Standard Package	25
Standard Package Unit	Each
Min Order Qty	1
Weight/Ea	22 lbs

Notes

Torque Anchor Extreme Helix; 10,000 ft lbs (13,558 N-M), 8" (203 mm) x 3/8" (9.52mm) Helix for use with 3/4" (19.1 mm) or 1" (25.4 mm) rod