

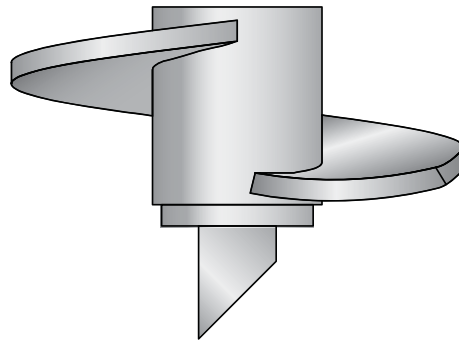

HTAX-225-100 (8) -- Heavy Torque Anchor Extreme Helix



Product Specifications

Anchor Style	Power Installed Torque Anchor
Number of Helices	1
Single Helix	8" (203 mm) x 1/2" (12.7mm)
Rod Diameter	3/4" (19.1 mm) or 1" (25.4 mm)
Torque Rating	15,000 ft lbs (20,340 N-M)
Square Hub	2.25" (57.2 mm)
Coating	Painted (optional Hot-Dip Galvanized)
Standard Package	25
Standard Package Unit	Each
Min Order Qty	1
Weight/Ea	21 lbs

Notes

Heavy Torque Anchor Extreme Helix; 15,000 ft lbs (20,340 N-M), 8" (203 mm) x 1/2" (12.7mm) Helix for use with 3/4" (19.1 mm) or 1" (25.4 mm) rod