

UTILITY ANCHORING

CATALOG



ECP

Designed and Engineered to Perform
www.getecp.com 1-866-327-0007

ECP Utility, a division of Earth Contact Products, engages in the design and manufacturing of a wide variety of transmission, distribution, substation, underground, OEM and telecom products used by utilities. ECP Utility products are also used in the residential construction, transportation, gas and water industries.

With more than 40 years of steel fabrication experience and having served the Electric Utility industry since 1998, ECP, proudly manufactures environmentally friendly helical anchors and foundations in our 100,000-sq. ft. facility in Olathe, KS.

Traditionally, helical anchors and piles have been used in tension and compression applications to support transmission and distribution towers as well as light poles. These applications have paved the way for new opportunities such as supporting substation structures, solar foundations, and pipelines.

We take great pride in providing tested anchors that are RUS Accepted and ICC Certified. Providing such excellence, requires using the best steel only America can provide.

ECP maintains a vast inventory of products to serve our customer's needs. Strategic distributors also maintain inventories to support customers across the country. When time is of the essence, count on ECP's network to provide you with the highest quality products and 24/7 customer service.

For more information on any of ECP's products please visit us online at www.GETECP.com.

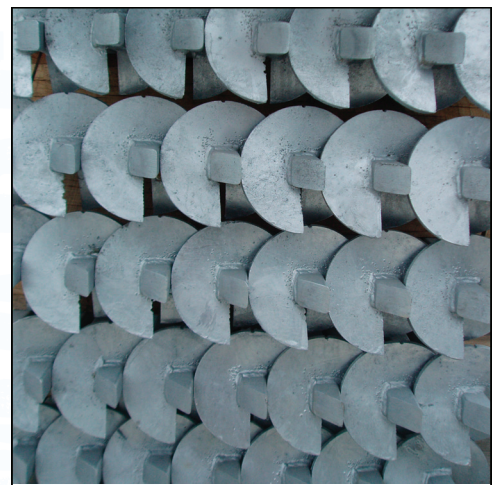

Designed and Engineered to Perform
www.ecputility.com 1-866-327-0007

1-3/8" Shaft 6000# Single Helix

Part #	Rod (in)	Helix (in)	Wt Ea (lbs)	Pallet
TAPL-625-10 08	5/8"	8	10	96
TAPL-100-10 08	3/4" or 1"	8	10	96
TAPL-625-10 10	5/8"	10	13	96
TAPL-100-10 10	3/4" or 1"	10	13	96
TAPL-625-10 12 *	5/8"	12	16	48
TAPL-100-10 12	3/4" or 1"	12	16	48
TAPL-100-10 14 *	3/4" or 1"	14	20.5	48

1-1/2" Shaft 7000# Single Helix

Part #	Rod (in)	Helix (in)	Wt Ea (lbs)	Pallet
TAP-625-10 08	5/8"	8	11	96
TAP-100-10 08	3/4" or 1"	8	11	96
TAP-625-10 10	5/8"	10	14	96
TAP-100-10 10	3/4" or 1"	10	14	96
TAP-625-10 12 *	5/8"	12	17	48
TAP-100-10 12	3/4" or 1"	12	17	48
TAP-100-10 14 *	3/4" or 1"	14	22	48

1-3/8" Shaft 6000# Double Helix

Part #	Rod (in)	Helix (in)	Wt Ea (lbs)	Pallet
TAPL-100-26 08-08	3/4" or 1"	8,8	21	32
TAPL-100-36 10-10	3/4" or 1"	10,10	33	28

1-1/2" Shaft 7000# Double Helix

Part #	Rod (in)	Helix (in)	Wt Ea (lbs)	Pallet
TAP-100-26 08-08	3/4" or 1"	8,8	26	32
TAP-100-36 10-10	3/4" or 1"	10,10	38	28

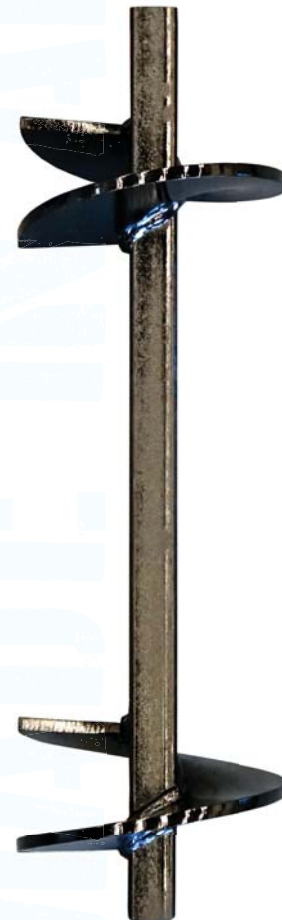
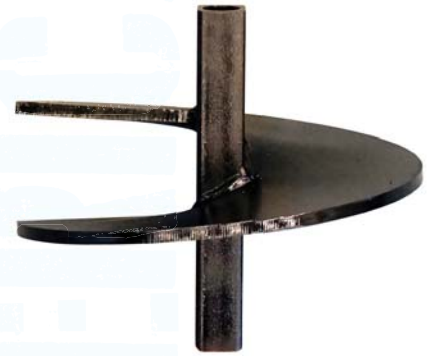

* RUS Approved

2-1/4" Hub 10,000 ft lbs. 3/8" Flight Thickness

Part #	Rod (in)	Helix (in)	Wt Ea (lbs)	Pallet
TAX-225-625 08	5/8"	8	10	96
TAX-225-100 08	3/4" or 1"	8	10	96
TAX-225-625 10	5/8"	10	13	96
TAX-225-100 10	3/4" or 1"	10	13	96
TAX-225-625 12	5/8"	12	16	48
TAX-225-100 12	3/4" or 1"	12	16	48
TAX-225-100 14	3/4" or 1"	14	20	48

2-1/4" Hub 10,000 ft lbs. 1/2" Flight Thickness

Part #	Rod (in)	Helix (in)	Wt Ea (lbs)	Pallet
HTAX-225-100 08	3/4" or 1"	8	12	96
HTAX-225-100 10	3/4" or 1"	10	15	96
HTAX-225-100 12	3/4" or 1"	12	20	48
HTAX-225-100 14	3/4" or 1"	14	25	48

2-1/2" Hub 15,000 ft lbs. 3/8" Flight Thickness

Part #	Rod (in)	Helix (in)	Wt Ea (lbs)	Pallet
TAX-250-625 08	5/8"	8	11	96
TAX-250-100 08	3/4" or 1"	8	11	96
TAX-250-625 10	5/8"	10	13.5	96
TAX-250-100 10	3/4" or 1"	10	13.5	96
TAX-250-625 12	5/8"	12	17	48
TAX-250-100 12	3/4" or 1"	12	17	48
TAX-250-100 14	3/4" or 1"	14	21	48

2-1/2" Hub 15,000 ft lbs. 1/2" Flight Thickness

Part #	Rod (in)	Helix (in)	Wt Ea (lbs)	Pallet
HTAX-250-100 08	3/4" or 1"	8"	14	96
HTAX-250-100 10	3/4" or 1"	10"	17	96
HTAX-250-100 12	3/4" or 1"	12"	22	48
HTAX-250-100 14	3/4" or 1"	14"	29	48

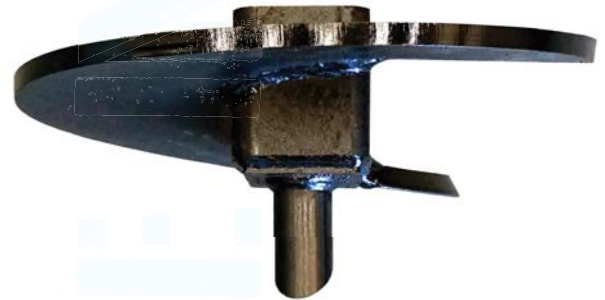

✱ RUS Approved

Designed and Engineered to Perform
www.ecputility.com **1-866-327-0007**

Power Installed Anchor Rods Combinations

Part #	Diam (in)	Eyenuit	Length (in)	Weight (lbs)	Pallet
TARN-625-421	5/8"	Single	42	5	50
TARN-625-422	5/8"	Double	42	5	50
TARN-625-841	5/8"	Single	84	9	50
TARN-625-842 *	5/8"	Double	84	9	50
TARN-625-843	5/8"	Triple	84	9	50
TARN-750-421	3/4"	Single	42	7	50
TARN-750-422	3/4"	Double	42	7	50
TARN-750-841	3/4"	Single	84	11	50
TARN-750-842	3/4"	Double	84	11	50
TARN-750-843 *	3/4"	Triple	84	11	50
TARN-100-421	1"	Single	42	12	50
TARN-100-422	1"	Double	42	12	50
TARN-100-841	1"	Single	84	19	50
TARN-100-842	1"	Double	84	19	50
TARN-100-843	1"	Triple	84	19	50

With Couplers

TARC-625-42	5/8"	Coupler	42	5	50
TARC-750-42	3/4"	Coupler	42	7	50
TARC-100-42	1"	Coupler	42	11	50

Power Installed Anchor Rods

Part #	Thread(in)	Size	Length	Tensile (lbs)	Wt (lbs)	Pallet
TAR-625-42	5/8"	5/8"	42"	16000	3.5	50
TAR-750-42	1"	3/4"	42"	23000	5	50
TAR-100-42	1"	1"	42"	36000	8.5	50
TAR-625-84 *	5/8"	5/8"	84"	16000	7	100
TAR-750-84 *	1"	3/4"	84"	23000	10	100
TAR-100-84	1"	1"	84"	36000	17	100

Power Installed Eye Nut

Part #	Rod (in)	Eye	Weight (lbs)	Box
TAN-625-001	5/8"	Single	1	25
TAN-100-001	3/4" or 1"	Single	2	25
TAN-625-002 *	5/8"	Double	2	25
TAN-100-002	3/4" or 1"	Double	2	25
TAN-625-003	5/8"	Triple	2	25
TAN-100-003 *	3/4" or 1"	Triple	2	25

Power Installed Coupler

Part #	Rod(in)	Wt.(lbs)	Tensile Strength (lbs)	Box
TAC-625	5/8"	0.5	16000	20
TAC-100	3/4" or 1"	0.5	36000	20



* RUS Approved

Designed and Engineered to Perform
www.ecputility.com 1-866-327-0007

1-1/2" 70,000 lbs Helical Anchors

Part #	Length (in)	Helix Dia (in)	Wt Ea (lbs)	Pallet
TAF-150-36 08-10 *	36	8,10	39	25
TAF-150-42 10-12	42	10,12	48	25
TAF-150-66 08-10-12 *	66	8,10,12	67	25
TAF-150-84 10-12-14	84	10,12,14	90	25
TAF-150-126 08-10-12-14	126	8,10,12,14	120	25
TAF-150-126 10-12-14-14	126	10,12,14,14	128	25

1-3/4" 100,000 lbs Helical Anchors

Part #	Length (in)	Helix Dia (in)	Wt Ea (lbs)	Pallet
TAF-175-36 08-10	36	8,10	48	25
TAF-175-42 10-12	42	10,12	62	25
TAF-175-66 08-10-12	66	8,10,12	82	25
TAF-175-84 10-12-14	84	10,12,14	106	25
TAF-175-126 08-10-12-14	126	8,10,12,14	146	25
TAF-175-126 10-12-14-14	126	10,12,14,14	156	25

1-1/2" 70,000 lbs Extension

Part #	Length (in)	Helix Dia (in)	Wt Ea (lbs)	Pallet
TAE-150-36	36	-	26	50
TAE-150-42	42	-	29	50
TAE-150-60	60	-	42	50
TAE-150-84	84	-	58	50
TAE-150-42 14	42	14	44	50
TAE-150-60 14	60	14	64	50

1-3/4" 100,000 lbs Extension

Part #	Length (in)	Helix Dia (in)	Wt Ea (lbs)	Pallet
TAE-175-36	36	-	35	50
TAE-175-42	42	-	38	50
TAE-175-60	60	-	57	50
TAE-175-84	84	-	78	50
TAE-175-42 14	42	14	54	50
TAE-175-60 14	60	14	73	50

Guy Wire Adapters

Part #	Length (in)	Size (in)	Wt Ea (lbs)	Pallet
TAA-150-103	19	1-1/2	15	50
TAA-175-103	20	1-3/4	16	50

* RUS Approved

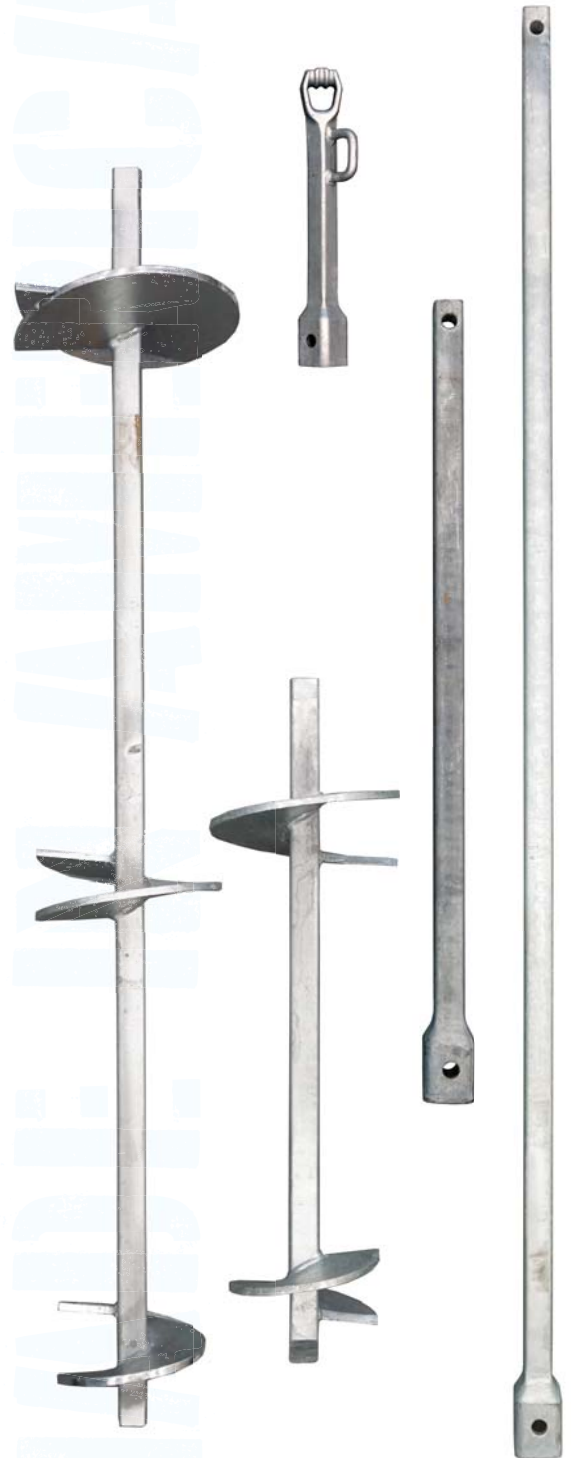

2-7/8" 80,000 lbs Helical Compression Piles

Part #	Length (in)	Helix Dia (in)	Wt Ea (lbs)	Pallet
TAH-288-60 12	60	12	41	25
TAF-288-60 08-10	60	08,10	54	25
TAF-288-60 10-12	60	10,12	57	25
TAF-288-84 10-12	84	10,12	74	25
TAF-288-84 08-10-12	84	8,10,12	77	25
TAF-288-84 10-12-14	84	10,12,14	87	25

3-1/2" 97,000 lbs Helical Compression Piles

Part #	Length (in)	Helix Dia (in)	Wt Ea (lbs)	Pallet
TAH-350-60 12	60	12	68	25
TAF-350-60 08-10	60	08,10	71	25
TAF-350-60 10-12	60	10,12	64	25
TAF-350-84 10-12	84	10,12	90	25
TAF-350-84 08-10-12	84	8,10,12	81	25
TAF-350-84 10-12-14	84	10,12,14	108	25

2-7/8" 80,000 lbs Extension

Part #	Length (in)	Helix Dia (in)	Wt Ea (lbs)	Pallet
TAE-288-36	36	-	25	50
TAE-288-60	42	-	42	50
TAE-288-84	60	-	56	50
TAE-288-36 14	36	14	44	25
TAE-288-60 14	60	14	64	25

3-1/2" 97,000 lbs Extension

Part #	Length (in)	Helix Dia (in)	Wt Ea (lbs)	Pallet
TAE-350-36	36	-	39	50
TAE-350-60	60	-	64	50
TAE350-84	84	-	85	50
TAE-350-36 14	36	14	72	25
TAE-350-60 14	60	14	91	25

Construction Cap

Part #	Length (in)	Width (in)	Wt Ea (lbs)	Pallet
TAB-288-NC	8	8	19	30
TAB-350-NC	8	8	24	30

* RUS Approved





Light Pole Foundation Anchors

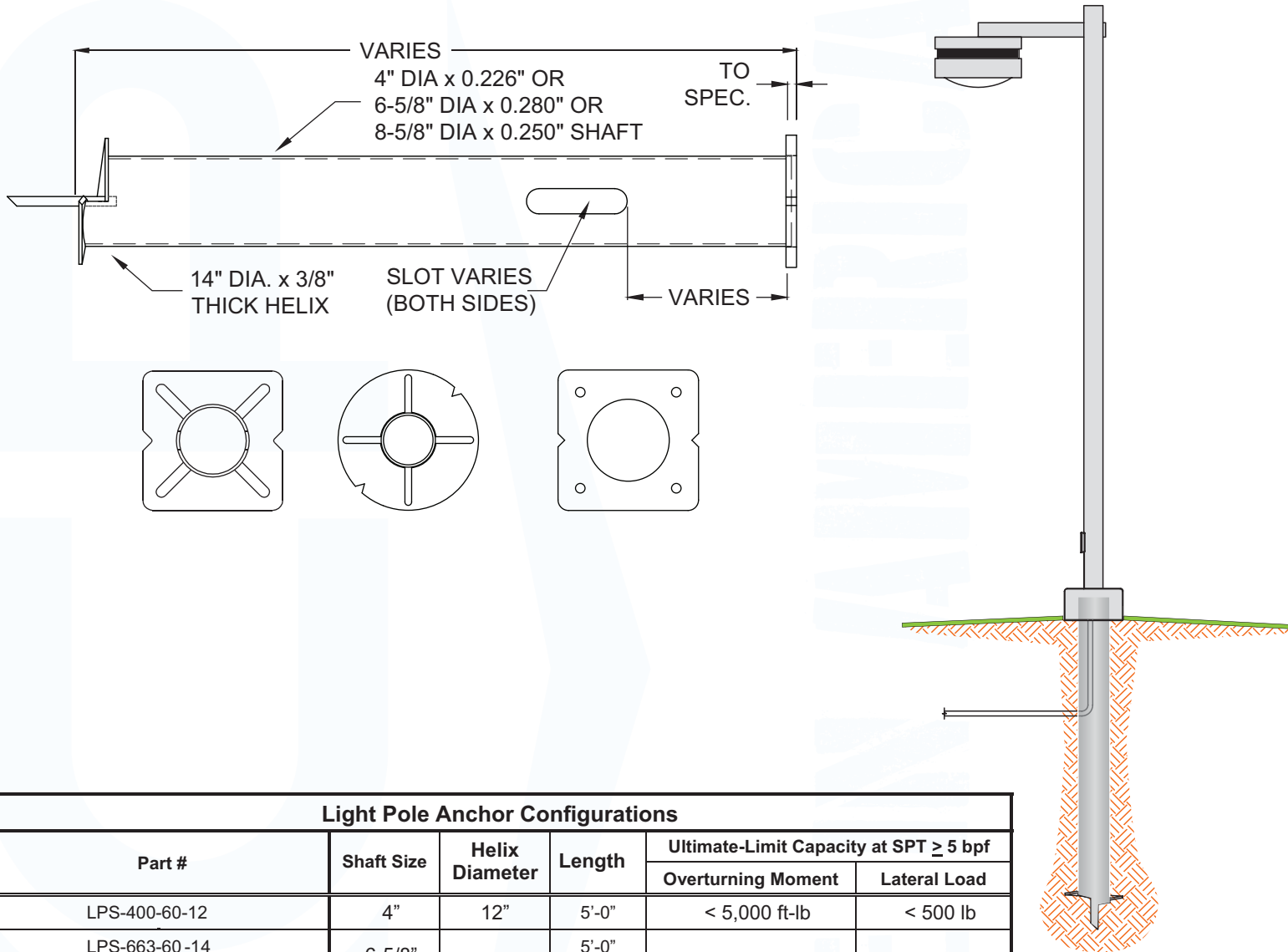

Light Pole Anchor Configurations					
Part #	Shaft Size	Helix Diameter	Length	Ultimate-Limit Capacity at SPT \geq 5 bpf	
				Overturning Moment	Lateral Load
LPS-400-60-12	4"	12"	5'-0"	< 5,000 ft-lb	< 500 lb
LPS-663-60-14	6-5/8" x 0.280" Wall	14"	5'-0"	< 12,000 ft-lb	< 1,000 lb
LPS-663-84-14			7'-0"		
LPS-663-120-14			10'-0"		
LPS-863-60-14	8-5/8" X 0.250" Wall	14"	5'-0"	< 17,500 ft-lb	< 1,200 lb
LPS-863-84-14			7'-0"		
LPS-863-120-14			10'-0"		

Notes: Standard Product Shown Includes:

Standard Integral Pile Cap - 1" thick x 15-3/4" Square pile cap welded to shaft

Standard 1-1/8" slots are designed for 1" diameter mounting bolts

Cable Access Slot available on both sides of shaft - (2" x 10" Standard)

Supplied Hot Dip Galvanized Per ASTM A123.

Stinger End (LPS) has single chamfer on bottom of shaft with a "stinger" for alignment

Special Product Designs Are Available: We fabricate custom light pole supports to your design specifications

Please allow extra time for Special Product Designs.

Designed and Engineered to Perform
www.ecputility.com 1-866-327-0007

Expanding (Bust) Anchor

Part #	Rod (in)	Hole (in)	Area (SQ IN)	Wt Ea (lbs)	Pallet
UAB-080-750 *	5/8 or 3/4	8	135	8	180
UAB-080-100	1	8	135	8	180
UAB-010-750	5/8 or 3/4	10	200	9	48
UAB-010-100	1	10	200	9	48
UAB-012-100	1	12	300	29	36
UAB-012-125	1.25	12	300	29	36



Expanding (Bust) Anchor Rods

Part #	Diam (in)	Length	Eye	Wt Ea (lbs)	Pallet
UAR-625-721	5/8	72	Single	7	50
UAR-625-722	5/8	72	Double	7	50
UAR-625-841	5/8	84	Single	8	50
UAR-625-842	5/8	84	Double	8	50
UAR-625-961	5/8	96	Single	9	50
UAR-625-962	5/8	96	Double	9	50
UAR-750-721	3/4	72	Single	10	50
UAR-750-722	3/4	72	Double	10	50
UAR-750-841	3/4	84	Single	11	50
UAR-750-842	3/4	84	Double	11	50
UAR-750-961	3/4	96	Single	12	50
UAR-750-962	3/4	96	Double	12	50
UAR-100-963	1	96	Triple	21	50
UAR-100-123	1	120	Triple	26	50



No Wrench

Part #	Diam (in)	Length	Helix (in)	Rating (Ft Lbs)	Wt Ea (lbs)	Pallet
TNW-750-543 04	3/4	54	4	400	10	30
TNW-750-663 06	3/4	66	6	1000	12	30
TNW-100-663 10	1	66	10	2300	30	30
TNW-125-663 10 *	1-1/4	66	10	2300	31	30
TNW-125-963 10 *	1-1/4	96	10	2300	42	20
TNW-125-963 14	1-1/4	96	14	2300	54	20
TNW-125-963 15	1-1/4	96	15	2300	58	20
TNE-125-24	1-1/4	24	-	2300	14	30

* RUS Approved

Designed and Engineered to Perform
www.ecputility.com 1-866-327-0007

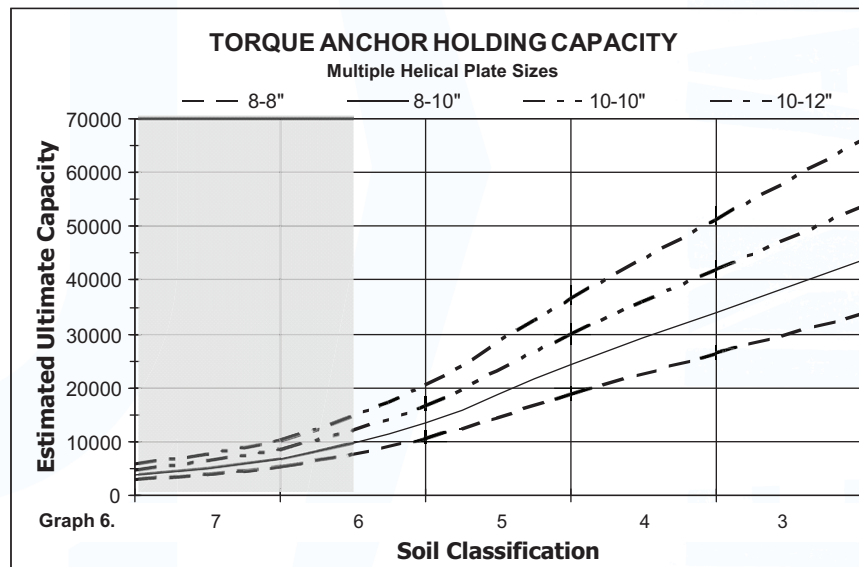
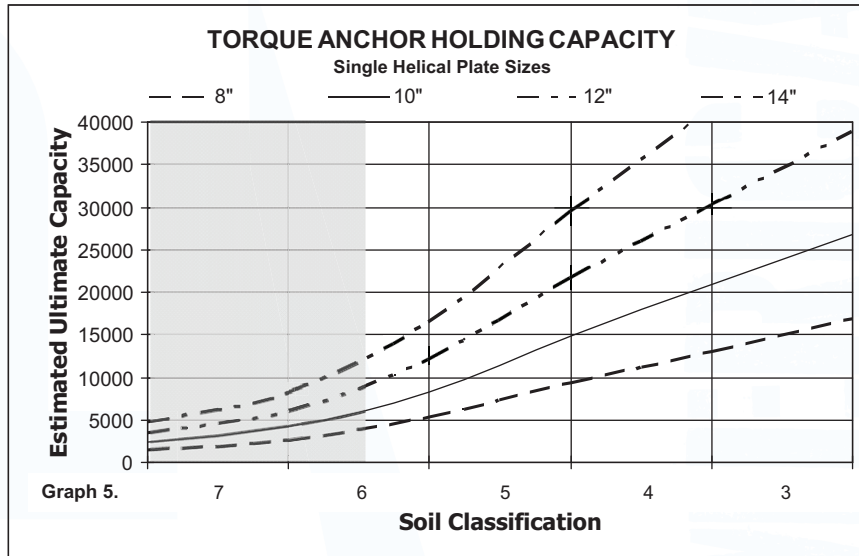

Maximum Holding Capacity of Expanding Anchor (lbs) vs Soil				
Class 3	Class 4	Class 5	Class 6	Class 7
16000	14000	11000	8500	5000
26500	22000	18000	15000	10000
31000	26500	21000	16500	12000
31000	26500	21000	16500	12000
40000	34000	26500	21500	16000
40000	34000	26500	21500	16000



ECP is proud to be a supplier of USA made Solar Foundations. Our presence within the Utility Industry has been through both helical and driven foundation applications. Contact your local ECP Manufacturer's Representative to inquire about how ECP can support your solar demands.



Designed and Engineered to Perform
www.ecputility.com 1-866-327-0007



Proudly Made in America

ECP

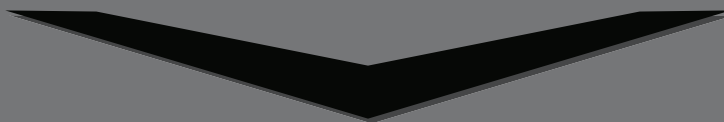

Designed and Engineered to Perform
www.getecp.com 1-866-327-0007
15612 South Keeler Terrace, Olathe, KS 66062